

See discussions, stats, and author profiles for this publication at: <https://www.researchgate.net/publication/315706059>

Development of a Programmable Mobile Robot

Article in *International Journal of Applied Engineering Research* · March 2016

CITATION

1

READS

91

4 authors, including:



Ademola Abdulkareem

Covenant University Ota Ogun State, Nigeria

70 PUBLICATIONS 151 CITATIONS

[SEE PROFILE](#)



Aremu Awosope Cladius Ojo

Covenant University Ota Ogun State, Nigeria

48 PUBLICATIONS 182 CITATIONS

[SEE PROFILE](#)



S.A. Daramola

Covenant University Ota Ogun State, Nigeria

21 PUBLICATIONS 180 CITATIONS

[SEE PROFILE](#)

Some of the authors of this publication are also working on these related projects:



Lecture Attendance System [View project](#)



Power System Quality Analysis [View project](#)

Development of a Programmable Mobile Robot

Ademola Abdulkareem

Department of Electrical and Information Engineering College of Engineering, Covenant University, Ota, Ogun State, Nigeria.
ademola.abdulkareem@covenantuniversity.edu.ng

C.O.A. Awosope

Department of Electrical Information Engineering College of Engineering, Covenant University, Ota, Ogun State, Nigeria.
Claudius.awosope@covenantuniversity.edu.ng

S. A. Daramola

Department of Electrical and Information Engineering College of Engineering, Covenant University, Ota, Ogun State, Nigeria.
Samuel.daramola@covenantuniversity.edu.ng

E. C. Nnorom

Department of Electrical Information Engineering College of Engineering, Covenant University, Ota, Ogun State, Nigeria.
ekele.nnorom@gmail.com

Abstract

In the world today, self-driving cars have proven to be a very interesting concept.

The concept of self-driving cars was exploded in 2004 during the DARPA Grand Challenge competition where fully autonomous vehicles competed against each other on a desert course.

The Stanford University's STANLEY was the winner of this competition. Ever since then there have been Junior by Stanford University, the Google self-driving cars, the European City Mobile Project among others. The necessary kinematic equations and algorithms for this mobile robot are obtained to ensure mobility and maneuverability of the robot. An Arduino-based controller circuit is built to implement the necessary algorithms, and servomotors are used to carry out independent wheel motion of the mobile robot. The obstacles are identified by means of tactile sensors; different shades of light are observed and in turn the zero normalized differential shade is calculated by means of the Phototransistors. The Infrared (IR) Sensors are needed to enable manual remote control escape in difficult terrains all of which make for a programmable mobile robot.

Keywords: Mobile Robot, Arduino® controller, tactile sensor, servomotors and phototransistors

Introduction

Robotics is a growing and vitally important field in the applied sciences. It is an interdisciplinary field and a viable area for research study. In this paper, an attempt was made to solve the navigation challenge in robotics. The work includes a study in robotics and the approaches undertaken in the design and construction of a programmable mobile robot. The procedures followed in solving the navigation problem of a mobile robot, choice of selection and the reason for the choice are discussed.

Robotics is a particularly interesting subject. The application of robots cuts across various fields in the society today. There

are agricultural robots, industrial robots, automobile robots, medical robots, teaching robots and so on.

A robot is a machine capable of carrying out a complex series of actions automatically, especially one programmable by a computer.

Robots were originally intended to amuse royalty. Several geniuses worked to build automatons for the royalty. Al-Jazari built a floating band that resembled humans and performed various songs and drum beats depending on the programming of a series of pegs.

The first user of the word "robot" was Karel Capek. The word "robot" is a Czech word spelled 'robota' meaning forced labor, compulsory service, drudgery. Robots are usually designed and constructed to do repetitive tasks which would be laborious for human beings to do. In 1961, an inventor named George Devol, installed his robot, Unimate, into a General Motors factory in Trenton, New Jersey. This was the first modern industrial robot to be constructed. Unimate would lift die-cut metal pieces and stack them for the human workers.

According to *Probabilistic Robotics*, robotics is the science of perceiving and manipulating the physical world through computer-controlled mechanical devices. According to *Wikipedia – the free encyclopedia*, robotics is the branch of technology that deals with the design, construction, operation, and application of robots, as well as computer systems for their control, sensory feedback, and information processing.

System Analysis

In the design of a mobile robot, different aspects that are very fundamental to an effective description of the system are investigated. These include the kinematics of the mobile robot wheels, the mobility of the robot, wheel constraints as well as degree of responsiveness of its sensors to make for object detection and avoidance.

Mobile robots comprise some primary components. These include the physical structure, the controller unit, external power source, sensors (light sensors, tactile sensors and Infra-

red sensors), the design of the mobile robot, all of which are discussed in this section.

The bottom-up approach of design has been adopted for this system. This involves developing all the subsystems and modules employed and the integration of these subsystems to yield at the entire system.

In this paper, in order to accomplish the tasks of mobility as well as object detection and avoidance, the mobile robot is designed as a two-degree-of-mobility mobile robot. The mobile robot is powered and controlled. Computer programs are developed to carry out the coordination of the motion..A skeletal presentation of the major components of the mobile robot is as shown in fig. 1.

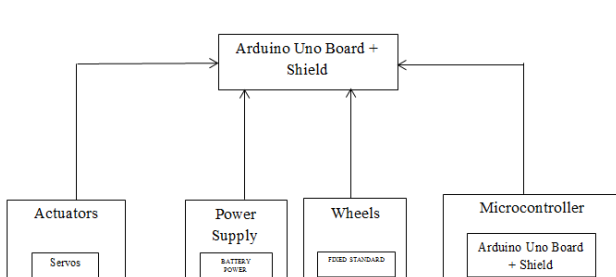

Fig. 1: Block Diagram of the Mobile Robot

Representing robot position

Given:

$\{X_g, Y_g\}$ axes-the basis on the plane representing the global frame from the origin O

P-the position of the robot chassis at its position reference point

$\{X_L, Y_L\}$ axes-the basis on the plane representing the local frame

$\{x, y\}$ coordinates-the position of P in the global reference frame is specified by coordinates x and y

α -The angular difference between the global and local reference frames.

ε – A vector representing the pose of the robot

ε_g – A vector representing the pose of the robot on the global reference frame

$$\varepsilon_g = \begin{bmatrix} x \\ y \\ \alpha \end{bmatrix} \quad (1)$$

To describe the robot’s position, the motion along axes of the global reference frame $\{X_g, Y_g\}$ must be mapped to the motion along axes of the robot’s local reference frame $\{X_L, Y_L\}$ using the orthogonal rotation matrix $R(\alpha)$.

$$R(\alpha) = \begin{bmatrix} \cos \alpha & \sin \alpha & 0 \\ -\sin \alpha & \cos \alpha & 0 \\ 0 & 0 & 1 \end{bmatrix} \quad (2)$$

Assuming, that the robot has rotated at angle $\alpha = \frac{\pi}{2}$ [1], then

$$R\left(\frac{\pi}{2}\right) = \begin{bmatrix} \cos \frac{\pi}{2} & \sin \frac{\pi}{2} & 0 \\ -\sin \frac{\pi}{2} & \cos \frac{\pi}{2} & 0 \\ 0 & 0 & 1 \end{bmatrix} \quad (3)$$

giving; the rotation matrix as

$$R\left(\frac{\pi}{2}\right) = \begin{bmatrix} 0 & 1 & 0 \\ -1 & 0 & 0 \\ 0 & 0 & 1 \end{bmatrix} \quad (4)$$

As such, the overall velocity of the robot is given as:

$$\dot{\varepsilon}_L = R\left(\frac{\pi}{2}\right)\dot{\varepsilon}_g \quad (5)$$

where

ε_L – A vector representing the pose of the robot on the local reference frame.

Given a velocity $(\dot{x}, \dot{y}, \dot{\alpha})$ in the global reference frame, its components of motion along the robot’s local axes can be computed as:

$$\dot{\varepsilon}_L = R\left(\frac{\pi}{2}\right)\dot{\varepsilon}_g = \begin{bmatrix} 0 & 1 & 0 \\ -1 & 0 & 0 \\ 0 & 0 & 1 \end{bmatrix} \begin{bmatrix} \dot{x} \\ \dot{y} \\ \dot{\alpha} \end{bmatrix} = \begin{bmatrix} \dot{y} \\ -\dot{x} \\ \dot{\alpha} \end{bmatrix} \quad (6)$$

Forward Kinematic Model

The forward kinematic model answers the question: how does the robot move, given the geometry and speeds of its wheels?

Given the following while considering the two front drive wheels:

D – diameter of each wheel,

P –the point at the center between the two drive wheels,

ϕ – distance between each wheel and P,

$\dot{\gamma}_1$ and $\dot{\gamma}_2$ – the spinning speeds of the wheels.

A Forward Kinematic model would predict the robot’s overall speed in the global reference frame.

$$\dot{\varepsilon}_g = \begin{bmatrix} \dot{x} \\ \dot{y} \\ \dot{\alpha} \end{bmatrix} = f(\phi, D, \alpha, \dot{\gamma}_1, \dot{\gamma}_2) \quad (7)$$

From equation (7) an equation $\dot{\varepsilon}_g$ for the vector representing the pose of the robot on the global reference frame can be derived as

$$\dot{\varepsilon}_g = R(\alpha)^{-1}\dot{\varepsilon}_L \quad (8)$$

If one wheel spins while the other wheel is stationary, since P is halfway between the two wheels, it will move instantaneously with half the speed.

$\dot{x}_{11} = \frac{1}{2}D\dot{\gamma}_1$ and $\dot{x}_{12} = \frac{1}{2}D\dot{\gamma}_2$, with these two contributions, \dot{x}_L a component of $\dot{\varepsilon}_L$ can be calculated.

Given that both wheels spin with equal speed but in opposite directions. The robot is stationary, $\dot{x}_L = 0$ and $\dot{y}_L = 0$ as neither wheel can contribute to sideways motion in robot’s reference frame.

Consider the right wheel (wheel 1), forward spin of this wheel causes a counterclockwise rotation of P as the robot pivots about wheel 2 [1].

Rotation velocities are:

$$w_1 = \frac{D\dot{\gamma}_1}{2\phi} \quad (9)$$

The same applies to the left wheel; its spin however is a clockwise rotation at point P:

$$w_2 = -\frac{D\dot{\gamma}_2}{2\phi} \quad (10)$$

$$\dot{\varepsilon}_g = [R(\alpha)]^{-1} \begin{bmatrix} \frac{D\dot{\gamma}_1}{2} + \frac{D\dot{\gamma}_2}{2} \\ 0 \\ \frac{D\dot{\gamma}_1}{2\phi} + \frac{-D\dot{\gamma}_2}{2\phi} \end{bmatrix} \quad (11)$$

For a square matrix, its inverse matrix is the same as its transpose.

Therefore

$$[R(\alpha)]^{-1} = \begin{bmatrix} \cos \alpha & -\sin \alpha & 0 \\ \sin \alpha & \cos \alpha & 0 \\ 0 & 0 & 1 \end{bmatrix} \quad (12)$$

Given: $\alpha = \frac{\pi}{2}$, $D = 1$, $\phi = 1$, $\gamma_1 = 4$, $\gamma_2 = 2$, the velocity in the global reference frame can be computed.

$$\dot{\epsilon}_g = \begin{bmatrix} \dot{x} \\ \dot{y} \\ \dot{\alpha} \end{bmatrix} = \begin{bmatrix} 0 & -1 & 0 \\ 1 & 0 & 0 \\ 0 & 0 & 1 \end{bmatrix} \begin{bmatrix} 3 \\ 0 \\ 1 \end{bmatrix} \quad (13)$$

Kinematic Constraints of the Wheel

In order to effectively model the kinematics of the robot, the first thing to do is to express the constraints on the individual wheels of the robot [1].

The following assumptions are made:

- (i) The plane of the wheel always remains vertical, having only one point of contact between the wheel and the ground plane.
- (ii) There is no sliding at this single point of contact. This means that the wheel undergoes rotation only under pure rolling conditions and rotation about the vertical axis through the contact points.

The following constraints apply to every wheel type:

- (i) Rolling Constraint: This enforces the concept of rolling contact. The wheel must roll when motion takes place in the appropriate direction.

No sliding constraint: This enforces the concept of no lateral slippage. The wheel must not slide orthogonal to its wheel plane [1].

The rolling constraint of the fixed standard wheel requires the motion along the direction of the wheel plane. This must be accompanied by the appropriate amount of wheel spin in order to have a pure rolling at the contact point [1]:

$$[\sin(\Omega + \lambda) - \cos(\Omega + \lambda)(-\phi) \cos \lambda]R(\alpha)\dot{\epsilon}_g - D\dot{\gamma} = 0 \quad (14)$$

The sliding constraint of the fixed standard wheel requires the component of the wheel's motion which is orthogonal to the wheel plane. This must be zero:

$$[\cos(\Omega + \lambda) \sin(\Omega + \lambda) D \sin \lambda]R(\alpha)\dot{\epsilon}_g = 0 \quad (15)$$

Maneuverability of a Mobile Robot

Given:

δ_M – Degree of maneuverability

δ_m – Degree of mobility

δ_s – Degree of steerability

The following formulae apply:

$$\delta_M = \delta_m + \delta_s \quad (16)$$

For a differential drive robot, $\delta_m = 2$ and $\delta_s = 0$. Hence

$$\delta_M = 2 + 0 = 2 \quad (17)$$

System Design and Construction

In the design and construction of a mobile robot, various aspects are considered. This involves the development of subsystems. As such, the design and construction of this mobile robot are seen in three categories; the mechanical hardware, the electrical hardware and the software controller.

Electrical Hardware

For the implementation of electrical circuit design, electrical circuits, especially complex ones, in this case are divided into individual circuitries. These individual circuitries are discussed in the sections that follow.

Power Supply

This part of the electrical circuit is implemented first because without the power supply, the components in the electrical circuit would not function. The power supply subsystem provides voltage for the various components of the mobile robot. Typically, in order to power an Arduino Microprocessor, an input voltage that is between 7 and 12V DC and a System voltage of 5V DC are required. However, the 5V for the System Voltage provided by a typical USB port cannot power the servos. As such, an external battery pack is used. When servos makes sudden direction changes or push against resistance to rotation, more current is drawn than that which the USB port can supply. Coupled with the fact that the mobile robot will not remain tethered to the computer, external 1.5-V AA batteries are used. This supplies the system with 7.5V and adequate current for voltage regulators and servos.

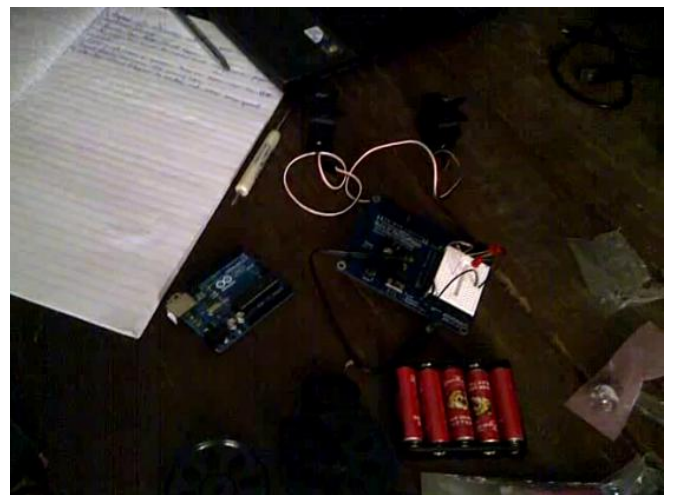

Fig. 2: AA Batteries providing power supply to Parallax Shield

Actuators

The actuators that are implemented here are servo motors. A servo motor is a rotary actuator which makes for precision in the control of the angular position [2]. A typical servo motor consists of a motor coupled to a potentiometer (in most cases) for position feedback, via a reduction gearbox. The servo motor implemented for this project is a Continuous Servo Motor.

In this paper, two (2) parallax servo motors are used with each servo connected to each wheel.

Parallax Continuous Servo

The Parallax Continuous Servo provides 180° range of motion and position control. The Parallax continuous Servo is controlled through pulse width modulation, where the position of the servo shaft is dependent on the duration of the pulse. In order to hold its position, the servo needs to receive a pulse every 20 ms.

Piezoelectric circuit

The Piezoelectric effect involves the conversion of energy between mechanical and electrical forms. The resulting

mechanical deformation results in an electrical charge. Microphones turn an acoustical pressure into a voltage. Alternatively, when an electrical charge is applied to a polarized crystal, the crystal undergoes a mechanical deformation which can, in turn, create an acoustical pressure. This is seen in piezoelectric speakers responsible for the system beeps commonly heard in computers [3].

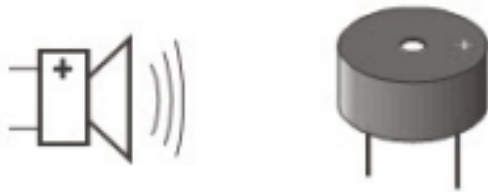

Fig. 3: The Piezoelectric Speaker

Tactile Sensors or Switches

Tactile switches are also called bumper switches or touch switches. Tactile sensors enable a robot to pick up an object or navigate to another conveyer belt. In automated factory lines, tactile switches are used to count objects, and to align parts for a certain step in a manufacturing process. In each case, the switches provide inputs that trigger a programmed output. The Whisker switches give the Mobile Robot the ability to sense its surroundings through touch as it roams around, much like a cat’s whiskers [4].

Light Sensors

The light sensors adapted to the construction reported in this paper respond to visible light, as well as the invisible infrared light. The light sensor used in this regard was the phototransistor. A transistor regulates the amount of electric current that passes through two of its three terminals. The third terminal on the other hand controls just how much current passes through the other two. The brightness of the light shining on the base of the phototransistor (B) terminal determines how much current it will allow to pass into its collector (C) terminal, and out through its emitter (E) terminal. Brighter light results in more current; less-bright light results in less current.

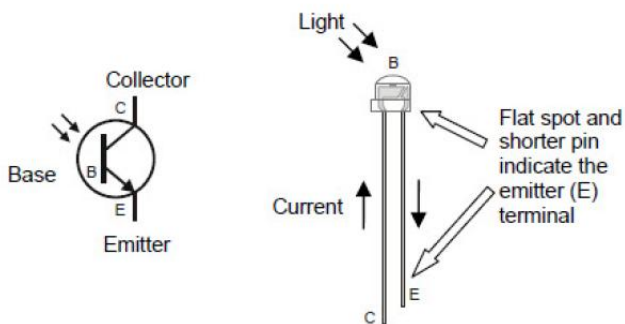

Fig.1: Diagrams of a Phototransistor showing the schematic and physical structures

-Calculations involving the phototransistor. The normalized differential measurement is used which does not simply stop movement of the mobile robot in the presence of brightness or in a dark environment. The difference in the intensity of the light falling on the light sensors is considered in this approach. The formula is given as

$$\text{normalized differential shade} = \frac{tRight}{tRight + tLeft} \tag{14}$$

This is improved by using the zero normalized differential shade giving us a range from -0.5 to +0.5.

$$\text{zero justified normalized differential shade} = \frac{tRight}{tRight + tLeft} - 0.5 \tag{15}$$

nanometers (frequency 430 THz) to 1 mm (300 GHz)[4]. Most of the thermal radiation emitted by objects near room temperature is infrared [5].

Microcontroller Unit (Arduino)

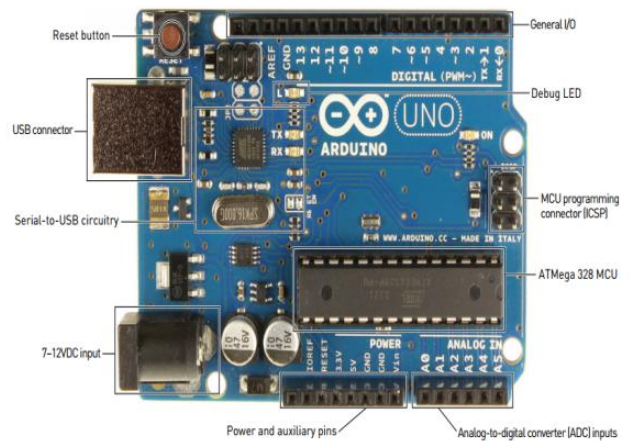

Figure 2 The Labeling of an Arduino Uno board

TABLE 1: showing the Serial Monitor Display of light falling on the Phototransistor

COM9		
tLeft	ndShade	tRight
1656.00	-0.04	1404.00
tLeft	ndShade	tRight
1672.00	0.46	42496.00
tLeft	ndShade	tRight
1672.00	0.46	44852.00

tLeft	ndShade	tRight
1676.00	0.47	47496.00
tLeft	ndShade	tRight
2344.00	0.46	52432.00
tLeft	ndShade	tRight
17360.00	-0.40	1828.00
tLeft	ndShade	tRight
24108.00	-0.44	1628.00
tLeft	ndShade	tRight
24352.00	0.11	38056.00
tLeft	ndShade	tRight
1668.00	0.46	39140.00
tLeft	ndShade	tRight
1672.00	0.46	35568.00
tLeft	ndShade	tRight
1664.00	0.10	2516.00
tLeft	ndShade	tRight
1656.00	-0.03	1440.00
tLeft	ndShade	tRight
1656.00	-0.04	1404.00

Infrared Receiver

Infrared Receiver (IR) refers to radiant energy in the electromagnetic spectrum with its wavelength longer than visible light typically not visible to the human eye. It extends from the nominal red edge of the visible spectrum at 700

The Arduino Uno is a microcontroller board based on the ATmega328 datasheet [6]. It has 14 digital input/output pins (6 out of which can be used as PWM outputs), 6 analog inputs, a 16-MHz ceramic resonator, a USB connection, a power jack, an ICSP (In Circuit Serial Programmer) header, and a reset button. It contains everything needed to support the microcontroller.

The Uno differs from all preceding boards in that it does not use the FTDI USB-to-serial driver chip. Instead, it features the Atmega16U2 (Atmega8U2 up to version R2) programmed as a USB-to-serial converter pins.

Shields

The expansions connectors are installed on shields. Shields allow the I/O Board to act like a miniature motherboard, providing mechanical and electrical connections to additional circuitry. A wide variety of shields are available, providing a wide array of expansion possibilities for the Arduino. The Board of Education Shield is utilized in this paper.

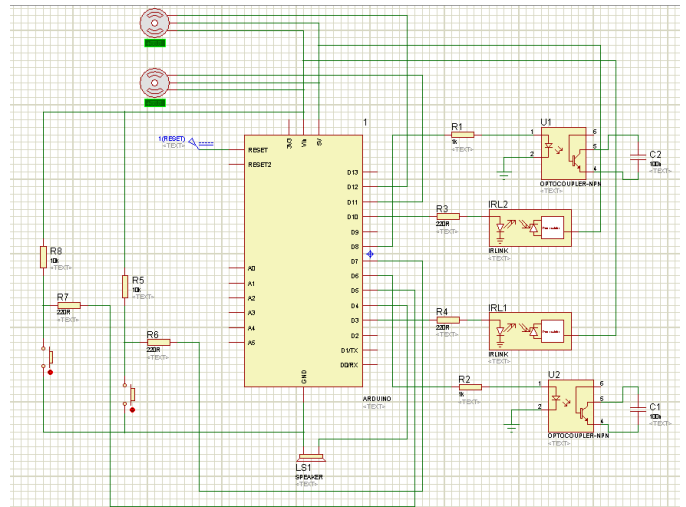

Fig.3: Complete Electrical Wiring

Mechanical Implementation

Having implemented the hardware and software of the electronics circuit, the next stage is the implementation of the mechanical part. The servo motors connected to the wheels enable the rotation of the wheels in differential wheel system. By this system, the two different wheels move in opposite directions in order to make a forward movement.

Mobile Robot Chassis

A chassis consists of an internal framework that supports a man-made object in its construction and use. It is analogous to the skeleton of an animal[7]. In this mobile robot, the chassis is a frame on which the electronics of the robot are mounted. These include the electronic circuitry including the Arduino Uno board, the Shield, breadboard circuitry as well as the connection of the servo motors.

Wheels

Two standard wheels and one free wheel were adopted.

Controller software

This refers to the instructions written to the Arduino in order for the device to perform certain functions. The codes which run on the Arduino were written using the Arduino IDE (Integrated Development Environment). The flowcharts for the entire processes in design of the robot are shown in figures 8 to 11.

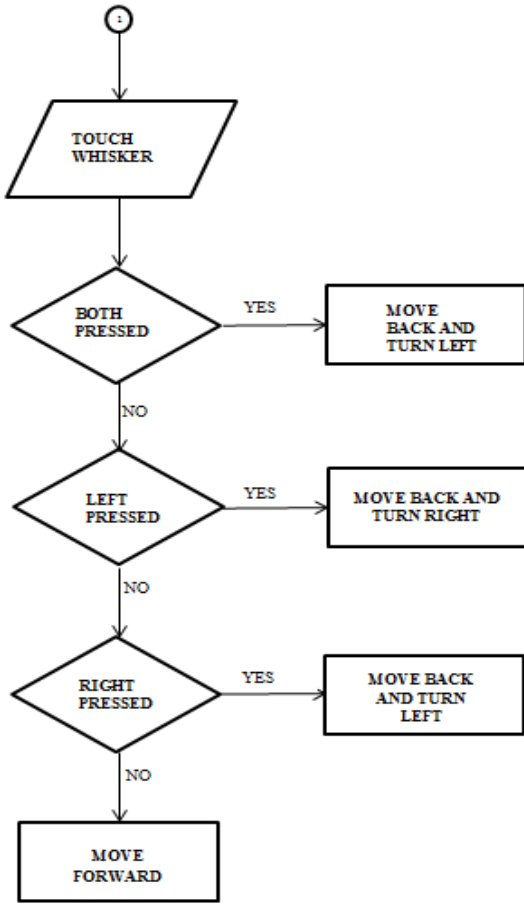

Fig. 7: Flowchart of Whisker Operations

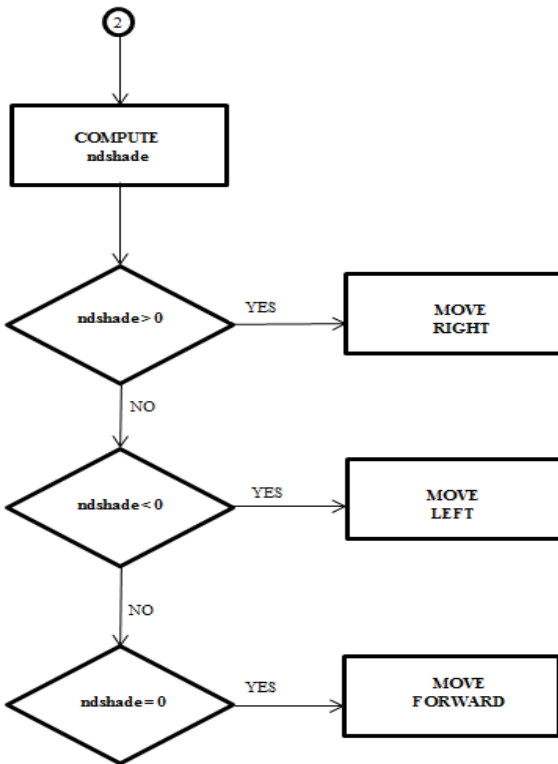

Fig.4: Flowchart of Light Navigation System

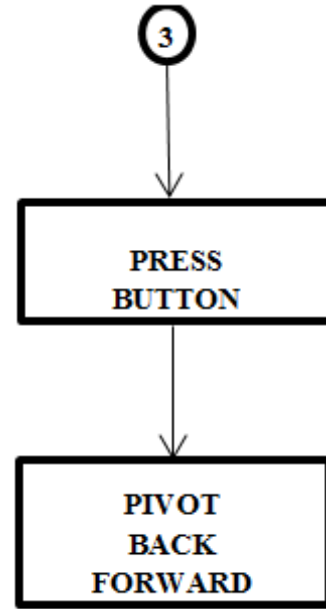

Fig. 9: Flowchart of Infrared (IR) System

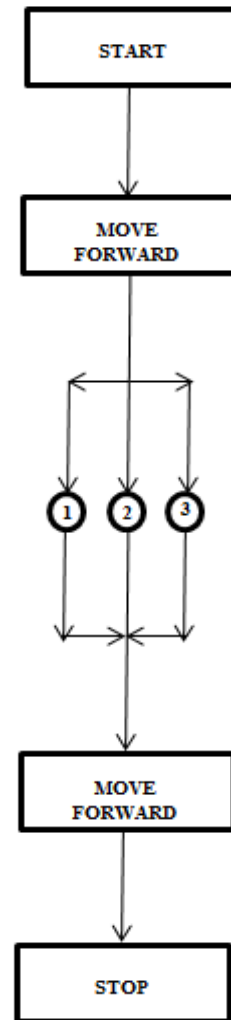

Fig. 10: Flowchart of Complete Robot

System Testing and Observation

The testing was a subsystem testing following a bottom-top approach. Adjustments were made to the entire robotic system. One major adjustment was changing from pin 13 to pin 11 when the servos were connected. Hence, the following components were tested: The servos and phototransistors.

Pin 11 ServoLeft	Pin 12 ServoRight	Description	Behavior
1700	1300	Full speed, pin 13 servo CC (counterclockwise), pin 12 servo C (clockwise).	Forward
1300	1700	Full speed, pin 13 servo C, pin 12 servo CC.	Backward
1700	1700	Full speed, pin 13 servo CC, pin 12 servo CC.	Right rotate
1300	1300	Full speed, pin 13 servo C, pin 12 servo C.	Left rotate
1500	1700	Pin 13 servo off, pin 12 full speed CC.	Pivot back left
1300	1500	Full speed, pin 13 servo C, pin 12 servo off.	Pivot back right
1500	1500	Both servos should stay still	Stopped
1520	1480	Slow, pin 13 servo CC, pin 12 servo C	Forward slow
1540	1460	Moderately slow, pin 13 servo CC pin 12 servo C	Forward medium
1700	1450	Pin 13 servo full speed CC, pin 12 servo moderate slow C.	Veer right
1550	1300	Pin 13 servo moderately slow CC, pin 12 servo full speed C.	Veer left

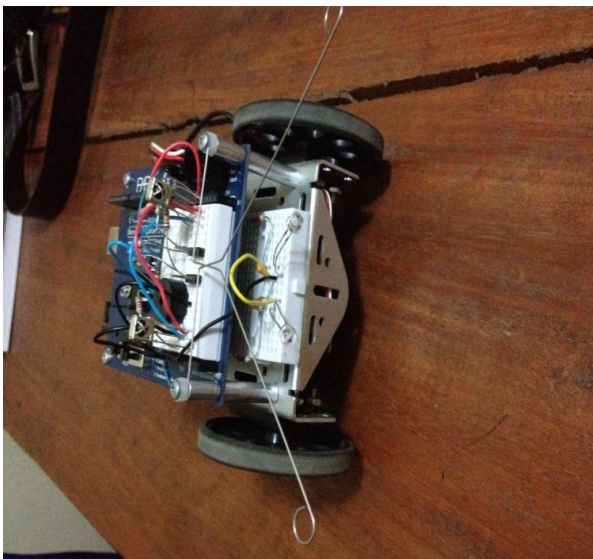

Figure 5 Picture of Complete Robot

Conclusion and Recommendation

In this project the salient issues regarding the analysis, modeling, design and construction of a mobile robot were

covered. Sufficient analysis and design were carried out in this paper in order to construct a prototype mobile robot. Consequently, a mathematical model of the mobile robot was developed. However, the following improvements can be applied to the present effort:

Robustness

This mobile robot would perform effectively a land gentle undulating terrain but would not be effective anywhere else. This is because of its differential drive mechanism. The stability of the robot would have to be increased to compensate for this by using another robot wheeled mechanism.

Sensitivity

This mobile robot adopted a pair of IR receivers and a pair of phototransistors as the input devices. Interference from the IR LEDs resulted in the need to remove these. To further improve on the sensitivity, the device should use better sensors such as the ultrasonic sensors and IR proximity sensors which do not offer such interferences.

Upgraded performance

New technologies should be adopted in order to improve the performance of the mobile robot. The robot could become fully AI (Artificially Intelligent) by adopting good localization technology like the S.L.A.M (Simultaneous Localization and Mapping), effective Motion Control and Computer Vision algorithms like the Hough Transform as well as object detection and recognition.

References

- [1]. Roland Siegwart and Illah R. Nourbakhsh. *Introduction to Autonomous Mobile Robots*. Cambridge, Massachusetts London, England : A Bradford Book The MIT Press, 2004. ISBN 0-262-19502-X.
- [2]. <http://en.wikipedia.org/wiki/Servomotor>. Modified and retrieved on 14th October, 2015
- [3]. <https://ccrma.stanford.edu/CCRMA/Courses/252/sensors/node7.html>. Retrieved on 16th July, 2015
- [4]. Liew, S. C. *Electromagnetic Waves*. 2006. Vols. Centre for Remote Imaging, Sensing and Processing.
- [5]. Hoover, Rachel (February 21, 2014). "Need to Track Organic Nano-Particle Across the Universe" February 22, 2014.
- [6]. http://www.atmel.com/dyn/resources/prod_documents/doc8161.pdf. (2009) Atmel cooperation All rights reserved.
- [7]. <http://en.wikipedia.org/wiki/Chassis>. (2007) modified July 2015